

Datasheet

# Microwave DALI DIMMING – DALI POWERED Sensor Range

Cucumber Microwave sensors feature high-quality components that deliver superior detection. Operating at a frequency of 24GHz, these sensors reduce interference and enhance performance.

With a detection range of up to 34m x 8m, fewer sensors are needed in large areas like corridors or challenging placements. Additionally, the smart mode enables the sensor to adapt to its environment, optimising detection, energy savings, and user comfort.

- Learning mode allows the sensor to adapt to its environment
- Colour coded housings = yellow for switching; green for dimming; blue for DALI powered
- Technology you can trust, independently tested in the UK
- Large wiring compartment with pluggable connectors
- High performance 24 GHz frequency to prevent interference
- Effortless programming via the free Cucumber app

## Detection range

Corridor application

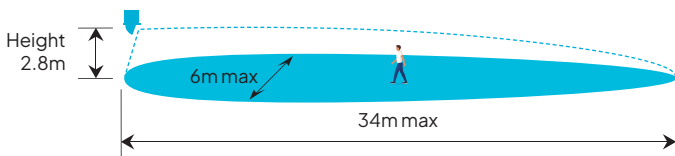

Open area application

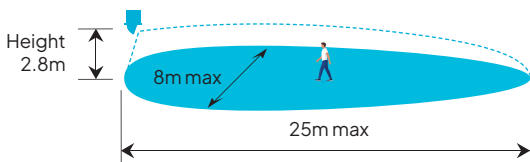

Distances shown with sensor set to Optimum sensitivity

MWDALICLR  
Range



### Specifications

<b>Supply Voltage</b>	Via DALI PSU (9.5VDC to 22VDC)
<b>No of DALI Drivers</b>	64 max.
<b>Parasitic Power Consumption</b>	515mW
<b>Terminal Capacity</b>	0.5mm <sup>2</sup> to 1.5mm <sup>2</sup>
<b>Time Out Period</b>	1 second to 240 minutes
<b>Working Temperature</b>	-10 to +35°C
<b>Impact Resistance</b>	IK04
<b>IP Rating (flush mounted)</b>	Standard versions: IP20 IP versions: IP65
<b>Unit Weight</b>	0.126kg
<b>Material (Casing)</b>	ABS Dev962 UL 94 VO

### Compliance

2014/35/EU Low Voltage Directive  
2014/30/EU Electromagnetic Compatibility Directive  
2014/53/EU Radio Equipment Directive  
2011/65/EU Restriction of Hazardous Substances (RoHS) Directive

### Microwave Safety

The microwave radiation emitted by this product is extremely low power and complies with International Standard "IEEE C95.1-2019 Standard for Safety Levels with Respect to Human Exposure to Electric, Magnetic and Electromagnetic Fields, 0Hz to 300GHz.

### BLE (Bluetooth) Transceiver

<b>Protocol</b>	Bluetooth
<b>Operation frequency</b>	2.4 GHz
<b>Transmission Power</b>	10 dBm
<b>Typical Range (indoor)</b>	10 to 30m max. in free air with direct line of sight

## Dimensions

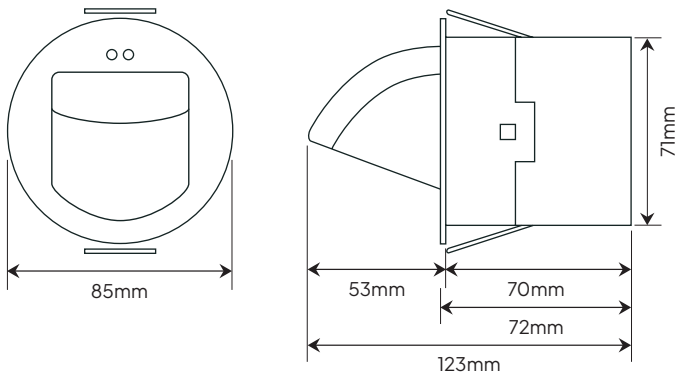

## Wiring

Terminate cables into connections as per wiring diagram below and fit wiring cover.

Secure the cable/bar clamp using 14mm screws (supplied). Do not overtighten.

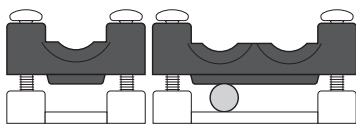

clamp for cable Ø 3–7mm

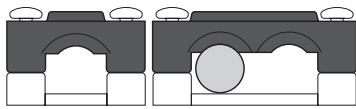

clamp for cable Ø 7.5–12mm

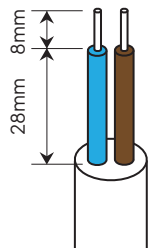

Typical cable preparation.

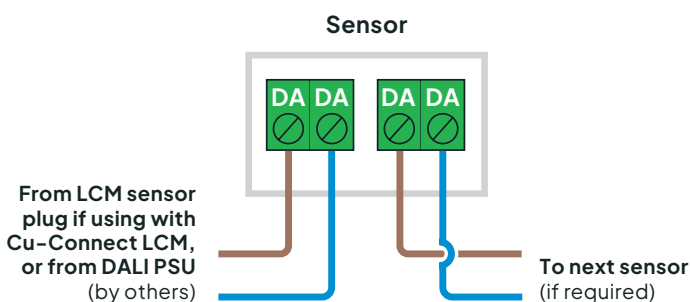

The pluggable green connectors can be removed from the sensor if needed to make wiring easier.

If supplying your own cable for sensor connections, please use 2-core 0.75mm<sup>2</sup> (min.) Mains rated cable. The working voltage of the sensor is 16V approx, but as DALI Connections are not defined as Safety Extra Low Voltage (SELV), Mains-rated cable must be used for connections.

## Flush fixing

- 1) Drill a Ø 73mm hole in the ceiling.
- 2) Wire connections as shown above, and fit wiring cover.
- 3) Push springs upwards and insert the sensor into the hole.
- 4) The flat face of the sensor head should face the intended detection area.

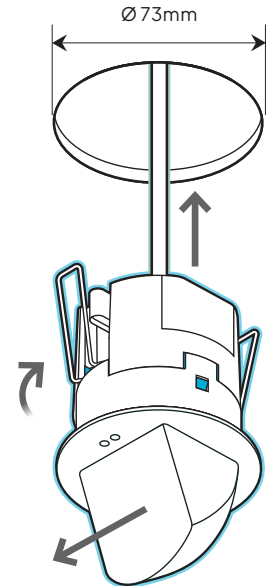

## Surface fixing

- 1) Separate head and power supply by pressing the green release lug.
- 2) Remove springs by pressing spring legs together, and unhook them from the power supply body.
- 3) Wire connections as shown above, and fit wiring cover.
- 4) Refit head to power supply.
- 5) Fix direct to surface using suitable 3.5mm or No.6 screws (not supplied), ensuring the flat face of the sensor head is facing the intended detection area when sensor head is refitted.

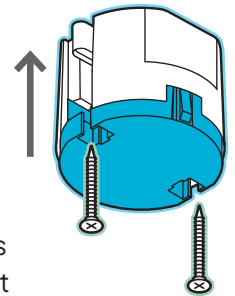
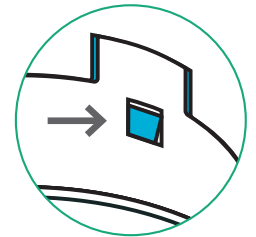

OR

- 6) Fit to optional surface mount kit (MWSMKW (White) or MWSMKB (Black) sold separately) which provides rotational adjustment for the sensor head position.
- 7) Attach the surface mounting sleeves (SMSLW (White) or SMSLB (Black) sold separately) to the sensor.

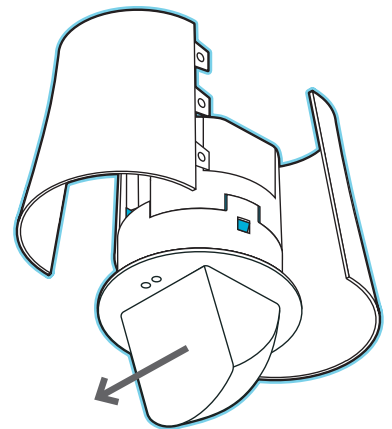

**WARNING:** This device should be installed by a qualified electrician in accordance with the latest edition of the UK Wiring regulations.

## Fixing to BESA box

- 1) Separate head and power supply by pressing the green release lug.
- 2) Remove springs by pressing spring legs together, and unhook them from the power supply body.
- 3) Before wiring power supply, if rotational adjustment for sensor head position is needed, fix optional surface mount kit (MWSMKW (White) or MWSMKB (Black) sold separately) to the BESA box using suitable M4 screws (not supplied).
- 4) After wiring the power supply, fix the power supply to the surface mount ring using the 2 No. M4 x 16 screws provided with the kit.
- 5) Refit head to the power supply. Attach the surface mounting sleeves (SMSLW (White) or SMSLB (Black) sold separately) to the sensor.
- 6) Rotate the sensor so that the flat face of the sensor faces the intended detection area. Remove the fixing pin from the ring and insert it into the small hole on the side of the mounting ring.

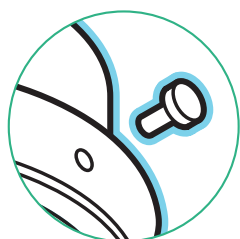
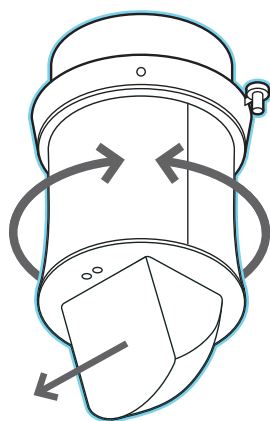
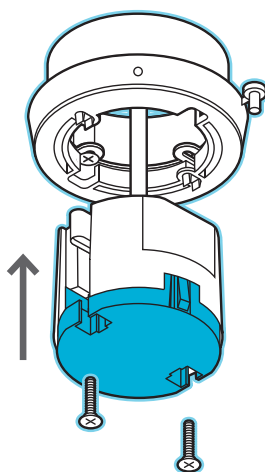
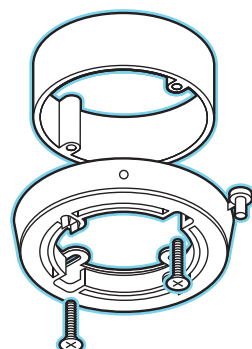
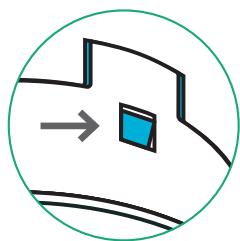

## Installation precautions:

- Do not fix the sensor to an unstable or vibrating surface.
- Do not position unit within 1m of any ventilation or forced heating.
- Avoid sunlight directly entering the photocell on the front of the sensor.
- Flush-mounting Bluetooth Low Energy (BLE) devices inside metal enclosures is not recommended.
- Mounting distance between sensors: Do not mount this sensor within 1 metre of another microwave sensor.
- For optimum performance with this product, please use the calibration feature provided within the App when commissioning.
- BLE networking ("meshing") between devices: Although BLE range between devices can be up to 30m in direct line of sight, this distance can be affected by other external factors such as building fabric / materials and 3rd party technology. Therefore we would normally recommend BLE devices to be mounted a maximum of 10m to 20m apart (or closer if possible). If further distance between devices is required, please contact us.
- Detection range can be adversely affected by local environmental conditions e.g. metalwork, concrete / building structure etc.
- Mounting sensor in external (exposed) areas is not recommended, due to potential issues with false triggering due to inclement weather (wind / heavy rain, or irregular movement of objects within range etc.).
- If possible, please check on quality of mesh network between devices before proceeding with project.
- Please contact us for further design considerations if you are planning to mesh more than 50 BLE sensors and/or devices into the same network.
- If you have any queries with regards to above points please contact us for further details.



**WARNING:** This device should be installed by a qualified electrician in accordance with the latest edition of the UK Wiring regulations.

## Functionality and programming

The sensor can be programmed using the Cucumber Controls app via Bluetooth on your smart device. Please use the QR code below to download our app on either iOS or Android to set up the product. Basic functionality using sensor(s) as a non-networked product can be programmed using the 'Quick Start' menu option – please see list of basic parameters below:

Quick Start menu default parameter settings	
Presence/absence detection	Presence
Time out period	10 min
Maintained illuminance (MI target level)	1000 Lux approx
Lux switching	Off
Master override	Off
Temporary dim output level	100%
Sensor sensitivity	Optimised
Walk test	On for 24 hours after power up

If further configuration is required, including advanced dimming functionality and/or Bluetooth networking (meshing) between multiple sensors, please use the 'Network setup' option in the app. Further information for using the 'Network setup' can be found on our website.









Download our free Cucumber Controls app to set up the product





**WARNING:** This device should be installed by a qualified electrician in accordance with the latest edition of the UK Wiring regulations.

# Product Codes

Product Code		Description
MWDALICLRW		Microwave DALI Dimming Ceiling Sensor Recessed White RAL9010 - DALI Powered
MWDALICLRWIP		Microwave DALI Dimming Ceiling Sensor Recessed White RAL9010 IP65 - DALI Powered
MWDALICLRB		Microwave DALI Dimming Ceiling Sensor Recessed Black RAL9005 - DALI Powered
MWDALICLRBIP		Microwave DALI Dimming Ceiling Sensor Recessed Black RAL9005 IP65 - DALI Powered
SMKW		Surface Mount Kit - White
SMKB		Surface Mount Kit - Black
SMSLW		Surface Mount Sleeves - White
SMSLB		Surface Mount Sleeves - Black



Blackhill Dr, Wolverton Mill,  
Wolverton, Milton Keynes, MK12 5TS

**03330 347799**

**enquiries@cucumberlc.co.uk**

**www.cucumberlc.co.uk**

This datasheet and/or contents is subject to change without notice.  
Please always refer to the current release on our website  
[www.cucumberlc.co.uk/resources](http://www.cucumberlc.co.uk/resources).

For our Standard Terms & Conditions and Guarantee Policies please refer to our website at [www.cucumberlc.co.uk](http://www.cucumberlc.co.uk).

