

Cu-Connect Lighting Control Module 4-WAY



Cu-Connect LCMs cover every lighting control application – from basic marshalling boxes to fully addressable, connected ecosystems.

Simply choose the number of outputs required: 4, 8, or 12. As with all Cucumber Lighting Controls products, installation is straightforward. Metal fixing brackets are mounted first, and the LCM securely clips into place. It is suitable for drop rod, cable tray, slab, or BESA box installations.

- Saves on the wiring between devices, reducing installation time and associated costs
- Simple App options reducing time on-site for programming
- Configurable output channels supporting switching, dimming and scene recall functions
- Flexibility of connecting different switch types via our switch interface units
- Compact housing for a wide range of applications
- Suitable for new, refurbishment and listed building projects
- LCM has in-built emergency test relay that can be triggered via switch interface unit anywhere within the network

LCM Specifications

Supply Voltage	220VAC - 240VAC
Max Load (Total for LCM)	10 Amps @230VAC
Max Load per Connector	6 Amps @230VAC
Max No of Sensors	6
Max DALI Supply	217 mA @ 13.8V
IP Rating	IP20
Working Temperature	-10 to +35 °C
Humidity Range	5 to 95% non-condensing
Unit Weight	0.93 kg
Material (Casing)	ABS Dev962 UL 94 VO

Luminaire Plug Specifications

Rated Voltage	250VAC
Rated Current	10 Amps
IP Rating	IP20. IP40 When Connected
Working Temperature	Max Short Term: +45°C Continuous: +35 °C
Material (Casing)	UL94 V0 ABS, Black/Blue. Cover and baseplate is Polycarbonate ABS mix
Contact Screws	M3 silver plated brass contacts
Moulding Screws	M3 X 8mm Pan Head Pozidrive Screw (Thread rolling plastic)
Screw Tightening Torque	Contacts: Max: 0.5Nm Mouldings: Max 0.5Nm
Conductor Size	1mm ² to 2.5mm ²
Conductor Stripping length	9mm

Installation:

This device is designed to be ceiling-mounted or wall-mounted using supplied bracket.

- Install devices in the position shown on the installation drawings where possible.
- Always ensure that installation complies with relevant Building Regulations and that device wiring meets the requirements of the latest IET Wiring Regulations (BS7671).
- The bracket can be used to mount the LCM directly to a smooth, flat surface.

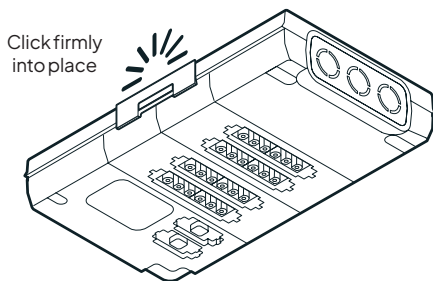
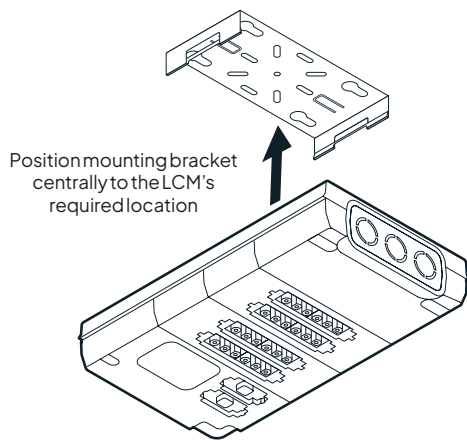

- Ensure that there is easy access to the wiring compartment and all connectors once the box is in place. Allow 170mm for total height of installed unit including connectors and cable.

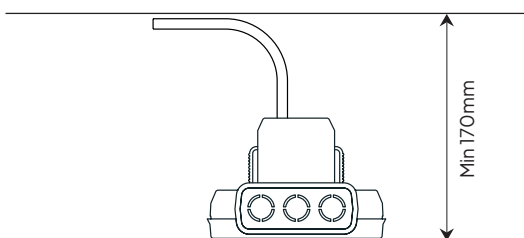

- Ensure that the LED indicator on the front corner of the LCM is visible from ground level for commissioning purposes. A short green LED pulse indicates LCM is 'healthy' under normal operating conditions.
- The 'test button' on the front corner of the LCM allows manual testing of lighting connections when LCM is initially powered up.
- Only connectors supplied or approved by Cucumber Lighting Controls shall be used with the LCM.
- The LCM should be disconnected from mains supply when plugging or unplugging any luminaire or sensor connector.
- The retaining means provided with the LCM must be used to support the cabling.
- Installation coupler systems described in this document are not replacements for the national domestic plug and socket outlet systems.
- Not suitable for installation in readily accessible areas.

LCM wiring connections:

Terminate cables into connections as per the wiring diagrams shown below. Secure the cable/bar clamp using 14mm screws (supplied). Do not overtighten.

- Connect Live Earth and Neutral to the LCM as below.

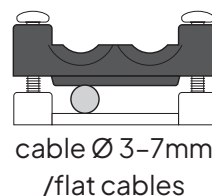
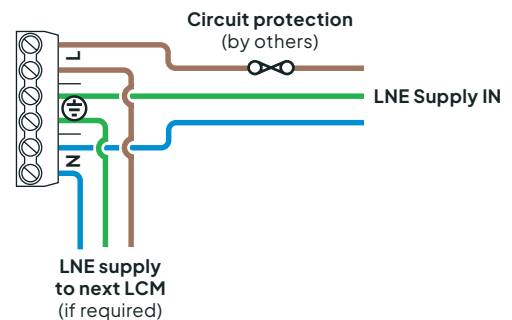

9mm

Typical stripping length for terminal connections.

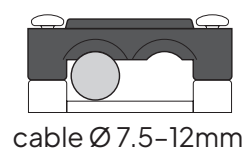

WARNING: This device should be installed by a qualified electrician in accordance with the latest edition of the UK Wiring regulations.

Sensor connections:

You must connect all detectors before programming the LCM.

- Both PIR and microwave sensors can be used with the LCM.
- Sensors plug into the associated ports on the front of the LCM, using 2-core flexes. Pre-wired sensor leads are available – please contact our sales office for details.
- Recommended cross sectional area 1mm² (CSA) of cable if contractor is supplying their own flexes, 50m max. total cable length between all sensors.

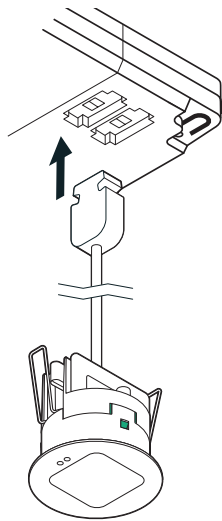

The pluggable green connectors can be removed from the sensor if needed to make wiring easier

LCM sensors plug connections:

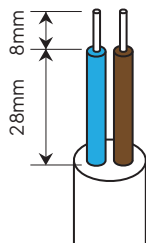
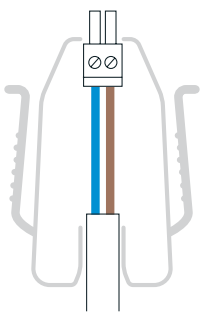

Typical cable preparation.

If supplying your own cable for sensor connections, please use 2-core 0.75mm² (min.) Mains rated cable. The working voltage of the sensor is 16V approx, but as DALI Connections are not defined as Safety Extra Low Voltage (SELV), Mains-rated cable must be used for connections.

Sensor wiring connections:

The pluggable green connectors can be removed from the sensor if needed to make wiring easier.

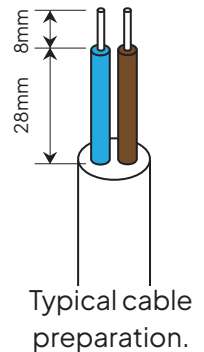
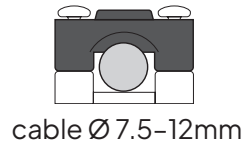
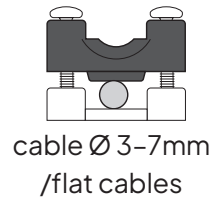
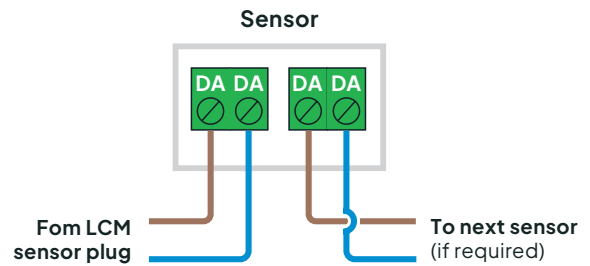

Secure the cable/bar clamp using 14mm screws (supplied). Do not overtighten.

Multiple sensors:

Up to 6 sensors can be connected to each LCM.

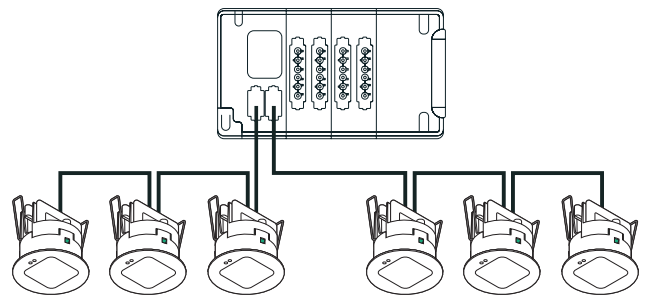

WARNING: This device should be installed by a qualified electrician in accordance with the latest edition of the UK Wiring regulations.

Luminaire connections:

The LCM is compatible with DALI, DALI-2 and D4i drivers, operating under a single master application controller without feedback facility.

You must use mains-rated cable with a minimum CSA of 1 mm².

Plug in the luminaires ensuring that the connector latches to the box (pre-wired luminaire leads are available - please contact our sales office for details).

Please leave additional length for the Earth wiring to ensure it is the last wire to disconnect and the first wire to connect if the cord is pulled or strained

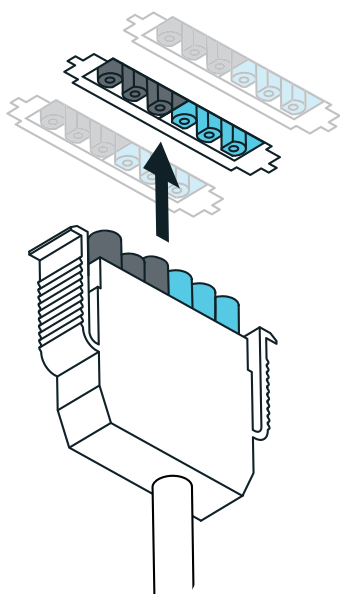

	1	Switched Live
	2	Earth
	3	Neutral
	4	Permanent Live
	5	DALI
	6	DALI

3 Core (switched live, earth and neutral) cable connection:

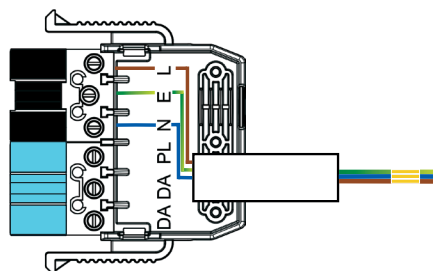

4 Core (switched live, earth, neutral and permanent live) cable connection:

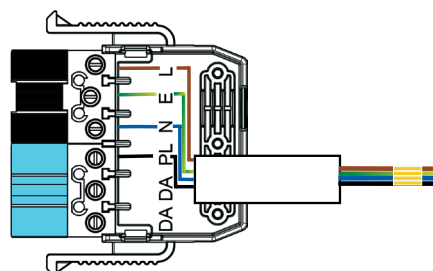

5 Core (switched live, earth, neutral and DALI pair) cable connection:

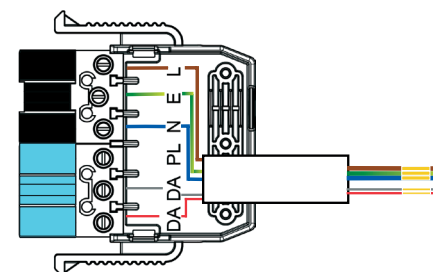

6 Core (switched live, earth, neutral, permanent live and DALI pair) cable connection:

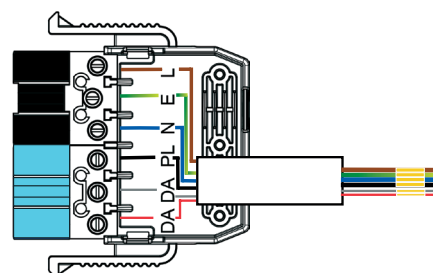

WARNING: This device should be installed by a qualified electrician in accordance with the latest edition of the UK Wiring regulations.

Functionality and programming

Please refer to user manual for set up and programming the LCM



Download our free Cucumber Lighting Controls app to set up the product



Dimensions

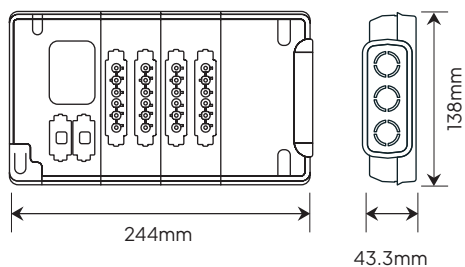

Product Code	Description
CuC-LCM4	Cu-Connect Lighting Control Module 4-way

This datasheet and/or contents is subject to change without notice. Please always refer to the current release on our website

www.cucumberlc.co.uk/resources.

For our Standard Terms & Conditions and Guarantee Policies please refer to our website at

www.cucumberlc.co.uk.



Blackhill Dr, Wolverton Mill,
Wolverton, Milton Keynes, MK12 5TS

03330 347799

enquiries@cucumberlc.co.uk

www.cucumberlc.co.uk

